

Specifications:

- 8' Hexayurt, plus one "gable"
- 166 square feet
- 13 sheets of 4' x 8' rigid insulation, at least 1" thick
- ___ feet of 3" tape
- ___ feet of 6" tape
- 2 people for 95% of the work
- Ships in 4' x 8' stack

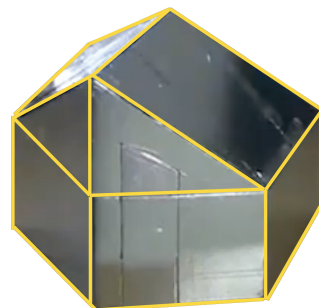

A good place for a door, more standing room, just 1 more panel than 8' hexayurt

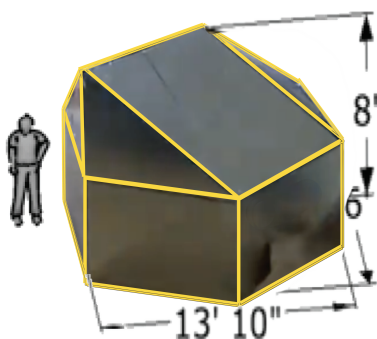
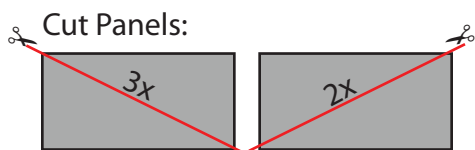

equals=

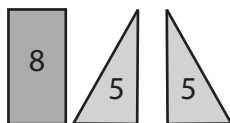

Most hexayurts ensure that the panels are cut so that all the logos face inside. This design can't, unless you produce two H13s at the same time.

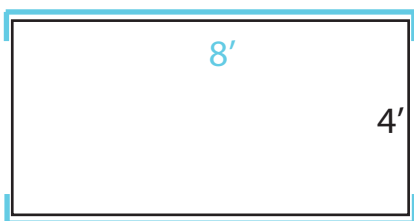
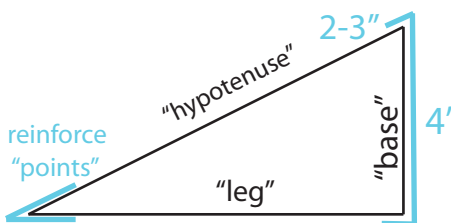

Taping plan: before making hinges, seal raw edges of certain panels with 3" wide tape: 8' side of **only 6 rectangles** & 4' side and 'points' of all triangles. You will have remaining edges to seal after making hinges.

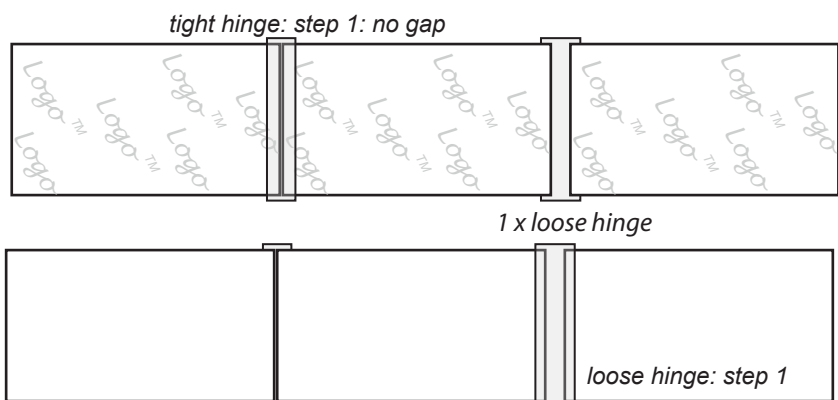

Connect 3 panels, with a tight hinge and a loose hinge to make a "half-wall." The loose hinge for walls has a gap equal to the thickness of your panel. Note which side of the panels the tape goes on in the "first step" or "inseam" of each hinge, this puts the logos on the inside of the yurt.

0.5 x loose hinge: step 1 (gap is 1/2 the thickness of panel)

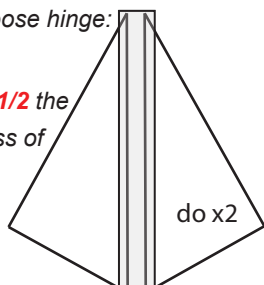

do x2
tight hinge: step 1 no gap!

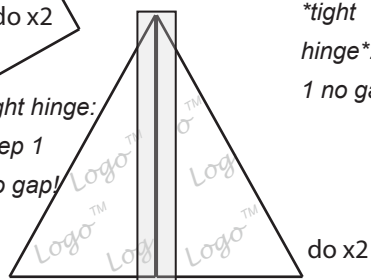

tight hinge: step 1 no gap!

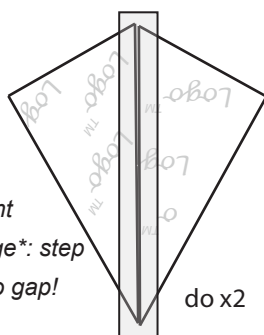

do x2

The roof hinges are more difficult. Start with the 0.5x loose hinge--the gap is 1/2 the thickness of the panel. Do this hinge x2 along the hypotenuse of two triangles, forming 2 "kites." Then connect to rectangle and right triangle w/ tight hinges (see final diagram below).

Last, do a *tight hinge along another pair of "kites." Start this hinge on the logo side of the panels.

*This hinge is a bit goofy. It could be a 1x loose hinge from the outside because the angle created is about 90 degrees, but this doesn't seem very stable. I prefer the stability of a tight hinge from inside the yurt (the logo side). I'd consider some 3" tape along this line after assembly to protect from rain. It's up to you.

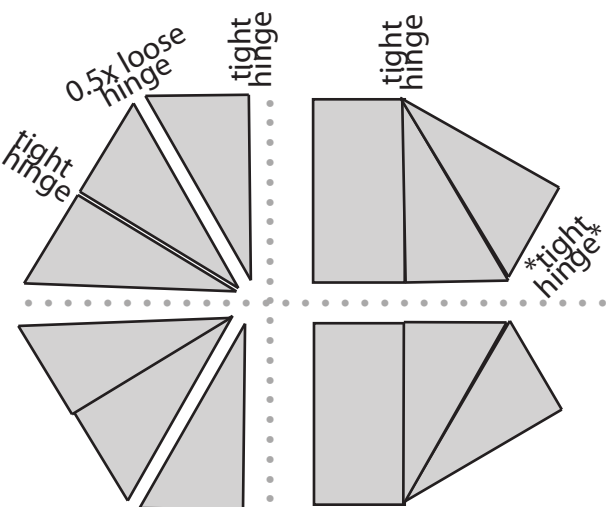

Finished product:
2 half-walls

4 roof sections: (2 big sections, 2 smaller "diamond" sections.)

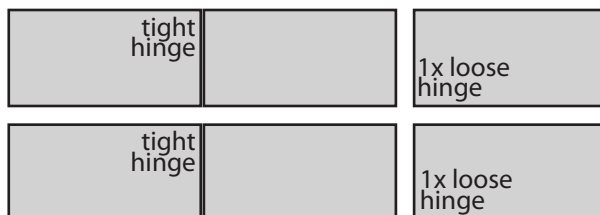

by Julie Danger. Warning: I have not built this yurt in full size yet! Other people have. I just think the hinges will work this way. I recommend you build this in model first!